



***Turbine Thermal Management
– Materials and Aerothermal Accomplishments –***

*M.A.Alvin
National Energy Technology Laboratory*

*2012 University Turbine Systems Research (UTSR)
Irvine, CA
October 2-4, 2012*



Advanced Turbines – DOE NETL Fossil Energy (FE) Goals

Advanced Technologies	Efficiency Increase, % points	Total Plant Cost, Reduction, 2007\$/kW	Cost of Electricity Reduction, 2007¢/kWh
All Technologies <i>Coal feed pump, gasifier materials and instrumentation, warm gas cleanup and hydrogen membrane separation, advanced hydrogen turbines, ion transport membranes, next generation advanced hydrogen turbines, advanced sensors and control</i>	+8	-\$800	-3.3
Advanced Hydrogen Turbine (AHT-1) <i>Higher pressure ratio, firing temperature and design for H₂-rich fuels to improve turbine performance; Increase in power rating for economy of scale benefit</i>	+1.8	-\$190	-0.7
Advanced Hydrogen Turbine (AHT-2) <i>Further turbine advancements increase pressure ratio, firing temperature, stage efficiencies and power rating</i>	+1.5	-\$20	-0.1

K.Gerdes, "The Potential of Advanced Technologies to Reduce IGCC Carbon Capture Costs," GTC Conference, Colorado Springs, CO, October 7, 2009

The NETL-RUA FWP 2012.03.02 – **Turbine Thermal Management** project supports the DOE FE Hydrogen Turbine Technology program through component-scale testing, demonstrating technology advancements to meet the DOE advanced turbine development goals. These goals include technology development that supports **3-5 percentage point efficiency increase**, and a **30 percent power increase** above hydrogen-fueled combined cycle baseline machines.

Advanced Turbines – DOE NETL Fossil Energy (FE) Goals

	Syngas Turbine 2010	Hydrogen-Fired Turbine 2015	Oxy-Fuel Turbine 2010	Oxy-Fuel Turbine 2015
Combustor Exhaust Temp, °C (°F)	~1480+ (~2700+)	~1480+ (~2700+)		
Turbine Inlet Temp, °C (°F)	~1370 (~2500)	~1425 (~2600)	~620 (~1150)	~760 (~1400) (HP) ~1760 (~3200) (IP)
Turbine Exhaust Temp, °C (°F)	~595 (~1100)	~595 (~1100)		
Turbine Inlet Pressure, psig	~265	~300	~450	~1500 (HP) ~625 (IP)
Combustor Exhaust Composition, %	CO ₂ (9.27) H ₂ O (8.5) N ₂ (72.8) Ar (0.8) O ₂ (8.6)	CO ₂ (1.4) H ₂ O (17.3) N ₂ (72.2) Ar (0.9) O ₂ (8.2)	H ₂ O (82) CO ₂ (17) O ₂ (0.1) N ₂ (1.1) Ar (1)	H ₂ O (75-90) CO ₂ (25-10) O ₂ , N ₂ , Ar (1.7)

R.A.Dennis, "FE Research Direction – Thermal Barrier Coatings and Health Monitoring Techniques," Workshop on Advanced Coating Materials and Technology for Extreme Environments, Pennsylvania State University, State College, PA, September 12 - 13, 2006

Turbine Thermal Management

– Programmatic Goals –

Overall Project Objectives

*Turbine Thermal Management consists of **four technical subtasks** that focus on a critical technology development in the areas of **heat transfer, materials development, and secondary flow control**.*

- *Collectively these projects contribute to achieving increased percentage point plant efficiency gain by permitting a higher turbine firing temperature as a result of*
 - *Realizing more effective airfoil cooling*
 - *Development and utilization of extreme temperature thermal barrier coating protection systems*
 - *System leakage flow reduction*

Turbine Thermal Management

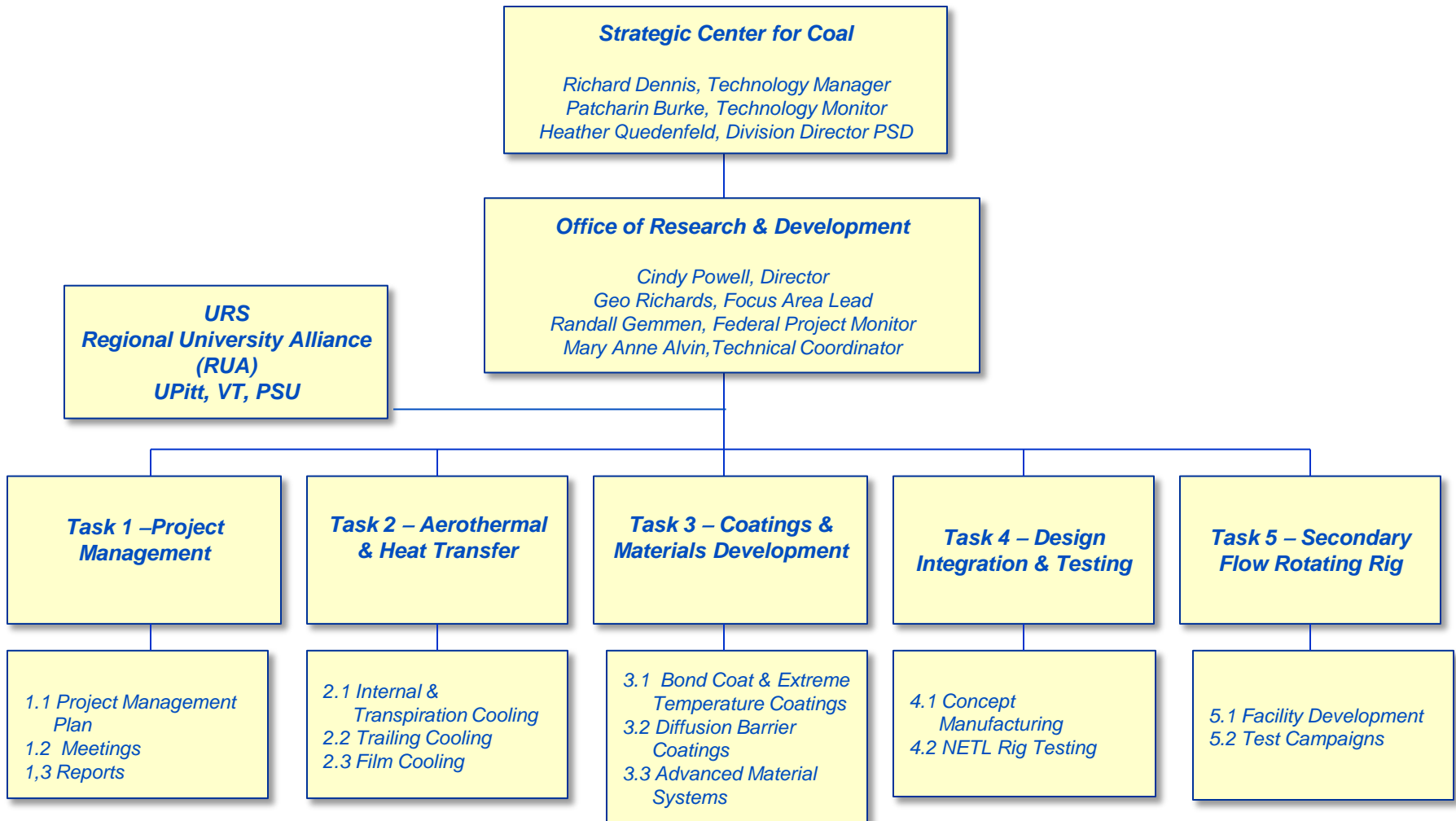

NETL-RUA Turbine Thermal Management Project

Task Goals/Objectives:

- Perform a collaborative materials and component development effort that **integrates** thermal protection systems – thermal barrier coatings, bond coats and diffusion protection layers – utilizing advanced but conventional substrate alloys, with advanced internal heat transfer surfaces and novel film cooling architectures
- Develop advanced , commercially manufacturable **material systems**: Stable in high temperature ($\geq 1400^{\circ}\text{C}$), high steam-content combustion gas environments.
- Develop **manufacturable cooling technologies**: Increase heat transfer enhancement factor nearly 5 times the smooth channel baseline
- Develop **core competency**: Design and proof-of-concept testing of the NETL-RUA Near Surface Embedded Micro-Channel (**NSEMC**) Concept¹
- Develop **manufacturable tripod hole designs**: 50% reduction in film cooling flow usage
- Utilize **state-of-the-art manufacturing technologies**: Design and fabrication of coupons and airfoils for proof-of-concept testing
- Address **alternate advanced material systems**: ODS & CMC
- Design/construct/operate an NETL-RUA world-class **rotating rig** for studying leakages, secondary flows and internal heat transfer in high speed rotating airfoils
- Demonstrate reduction of secondary flow leakages to reduce fuel burn (i.e., **3.34% leakage reduction = 1.95% fuel burn reduction**)

NETL-RUA Turbine Thermal Management Project

— Overall Approach —

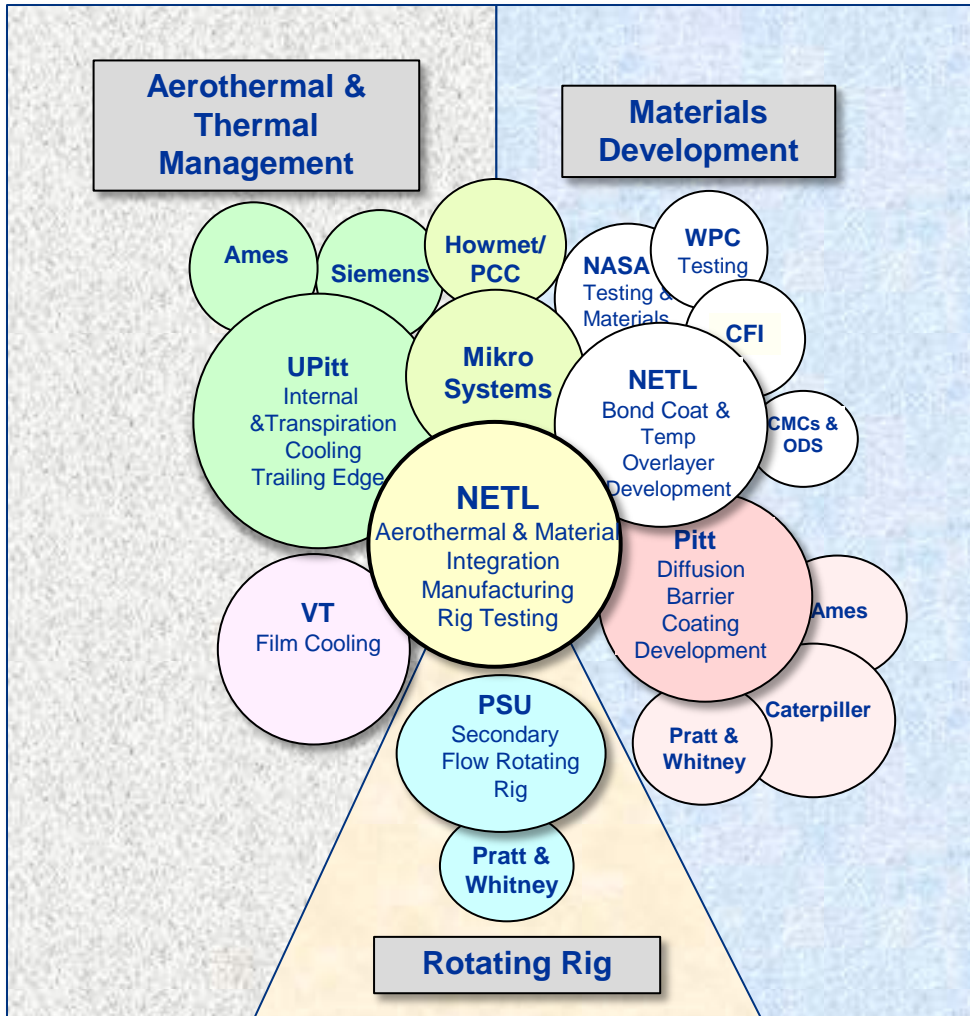

The **Turbine Thermal Management** project leverages government, academic, and industrial collaborations working synergistically in different aspects of aerothermal and materials issues to achieve the set overall goal through state-of-the-art analysis, modeling and testing.

The program is uniquely structured to address:

- (1) Development and Design of Aerothermal and Materials Concepts in FY12
- (2) Design and Manufacturing of these advanced concepts in FY13
- (3) Bench-Scale/Proof-of-Concept Testing of these concepts in FY13-FY14 and beyond

Turbine Thermal Management

Coatings and Materials Development

M.A.Alvin, NETL

K.Klotz and B.McMordie, Coatings for Industry

B.Gleeson and X.Wu, University of Pittsburgh

B.Warnes, Corrosion Control Consultants, Inc.

Stakeholders

Dr. Carlos Levi, UCSB

Dr. Yongho Sohn, UCF

Dr. Anand Kulkarni, Siemens Energy

Dr. Surinder Pabla, GE

Aerothermal Heat Transfer & Secondary Flow Rotating Rig

M.Chyu, S.Siw and N.Miller, University of Pittsburgh

S.Ekkad, C.LeBlanc and S.Ramesh, Virginia Tech

K.Thole and M.Barringer, J.Schmitz, A.Glahn, D.Cloud,

K.Clark, Penn State University/Pratt & Whitney

M.A.Alvin, D.Straub, S.Lawson, K.Caselton and T.Sidwell, NETL

Stakeholders

Dr. Ron Bunker, GE; Dr. John Marra, Siemens Energy

Dr. Klaus Braun, SwRI; Dr. Jim Heidmann, NASA GRC

Dr. Atul Kohli, PW; Dr. Dick River, WPAFB

Dr. Jim Downs, FTT; E.Razinsky, Solar Turbines

T.Shih, Purdue University

Turbine Thermal Management

Coatings and Materials Development

- *NETL Coating System Composite Architecture*
- *NETL-CFI Diffusion Bond Coat Development*
- *Diffusion Barrier Coatings*
- *High Temperature Thermal Flux Testing of Advanced Composite Architectures*

Aerothermal & Heat Transfer

- *Internal Airfoil Cooling*
- *Trailing Edge Cooling*
- *Tripod Hole Film Cooling*
- *NETL High Temperature, Pressurized Rig*
- *Secondary Flow Rotating Rig*

NETL Coating System Composite Architecture

– Extreme Temperatures/Steam-Containing Environments –

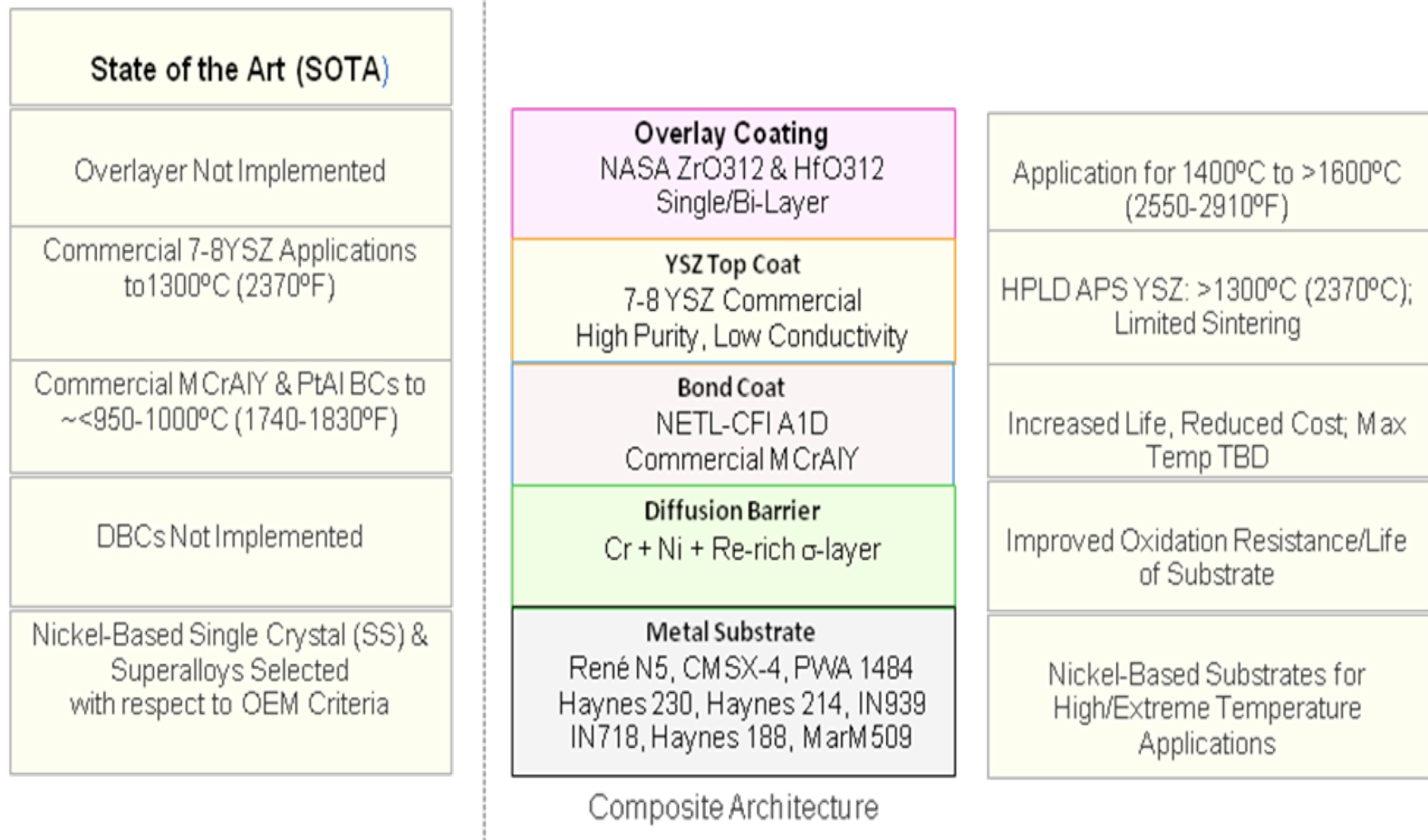

NETL-CFI Diffusion Bond Coat Development

Background – A1D Bond Coating

- *Bond coat development criteria*
 - *Reduced bond coat cost in comparison to current SOTA bond coat systems*
 - *Enhanced long-term high temperature oxidation resistance (1100°C)*
- *Modification of CFI's Alseal wet sprayed commercial product*
- *Bond coat development at NETL and CFI addressed diffusion bond coat systems fabrication*
 - *Low & high firing temperatures (high & low activity)*
 - *Without/with the addition of Hf*
 - *Various concentrations of Hf*
 - *Variations on the number of coating passes*

NETL-CFI Diffusion Bond Coat Development

Background – A1D Bond Coating

Aluminizing with Aseal A1D

- *Aseal A1D consists of aluminum, silicon and hafnium powder in an inorganic phosphate binder*
- *When heated to 885°C or more, the metal melts and reacts with the substrate to form a densified NiAl*
- *Undiffused reactants form a loose crust (bisque)*

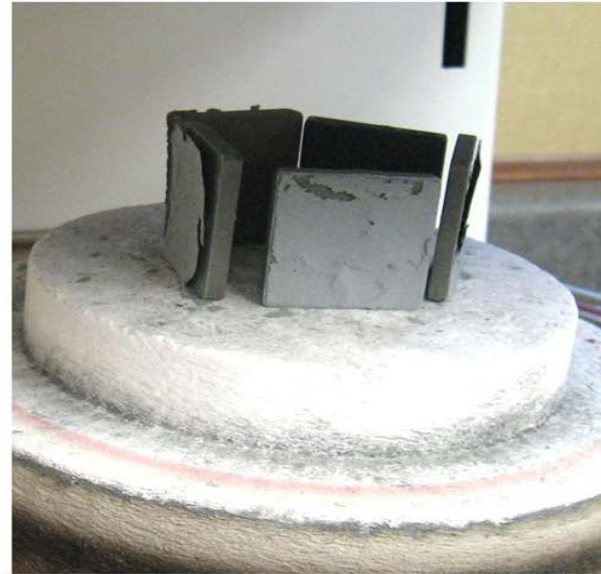

NETL-CFI Diffusion Bond Coat Development

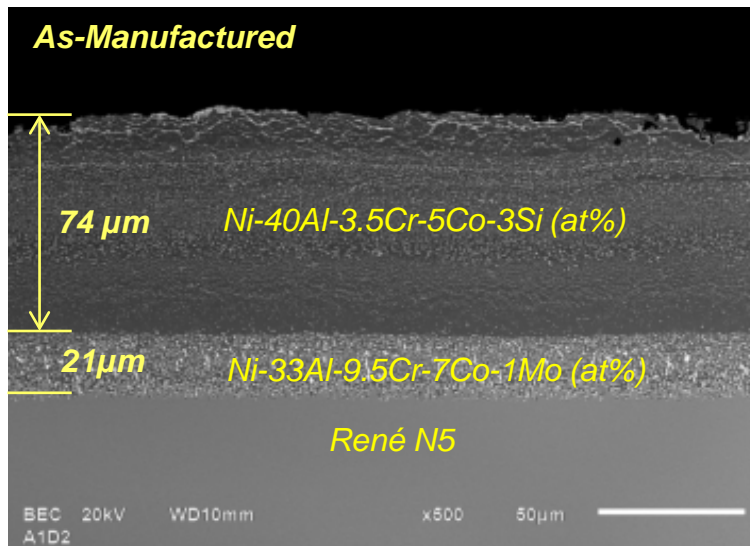

As-Manufactured A1D

- Uniformity of bond coat/interdiffusion thickness for all manufactured A1D series coupons: ~70-75 μm /
~20-25 μm (interdiffusion zone)
- Bond coat: Ni-rich β -NiAl matrix with additional elements in solid solution (Cr, Co and small amounts of refractory metals)
- Finely dispersed refractory-metal rich precipitates (Ta, W, Mo, Re) throughout the coating indicating that the bond coat is inwardly grown

Comparison of Diffusion Bond Coat Performance

– Cyclic Oxidation Testing at 1100°C in Static Air –

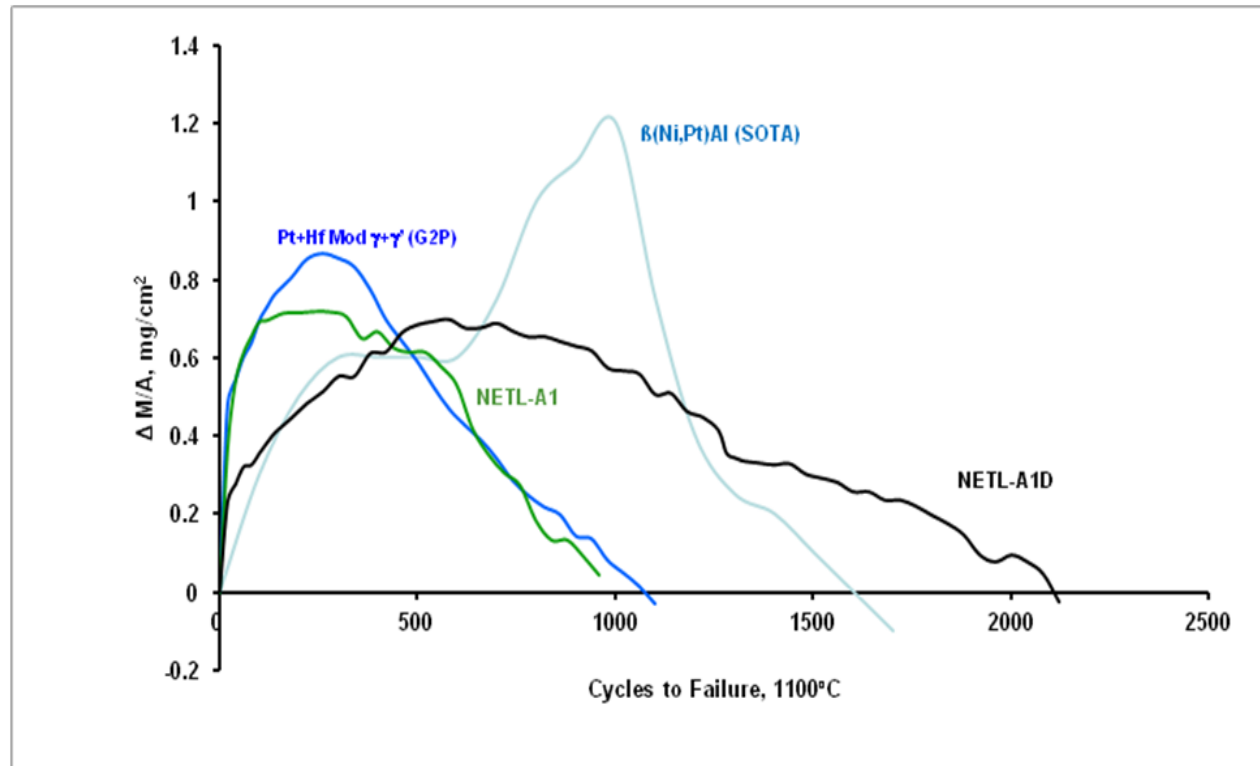

- The oxidation wt% change data was compared with SOTA β (Ni,Pt)Al, and Pt+Hf-Mod $\gamma-\gamma'$ diffusion bond coatings
 - ❖ A1D exceeded A1's cycle time-to-failure, Pt+Hf-Mod $\gamma-\gamma'$'s cycle time-to-failure, and at test termination, exceeded SOTA β (Ni,Pt)Al's cycle time-to-failure

Comparison of A1D and Current SOTA Diffusion and Overlay Bond Coat Systems

Bond Coat System	A1D	β-(Ni,Pt)Al (SOTA)	MCrAlY (SOTA)
Slow Growing & Adherent TGO	0	√√	0
Maintain Planar Nature <ul style="list-style-type: none"> Absence of Rumpling (Ratcheting) Retention/Adherence of Applied YSZ, Extending Service Operating Life 	√√	X	√
Compatibility with Substrate <ul style="list-style-type: none"> No Detrimental Secondary Reaction Zone Retention of Mechanical Properties 	√	X	X
Cost Effective	√√√	√	√√

Forward Direction

- Co-doping to enhance extended oxidation resistance performance
 - Integration with diffusion barrier coatings
- Application to alternate substrate nickel-based superalloys & single crystals

Diffusion Barrier Coatings

DBC Criteria

- *Extended high temperature oxidation resistance (8,000-30,000 hours)*
- *Minimal interdiffusion between substrate and surface modified region*
- *Diffusion barrier (i.e., Re-Cr-Ni compositions) to preclude aluminum-based coating and heat resistant superalloy or single crystal substrate interdiffusion and sustain protective coating properties*

Preparation of A1D / DBC System

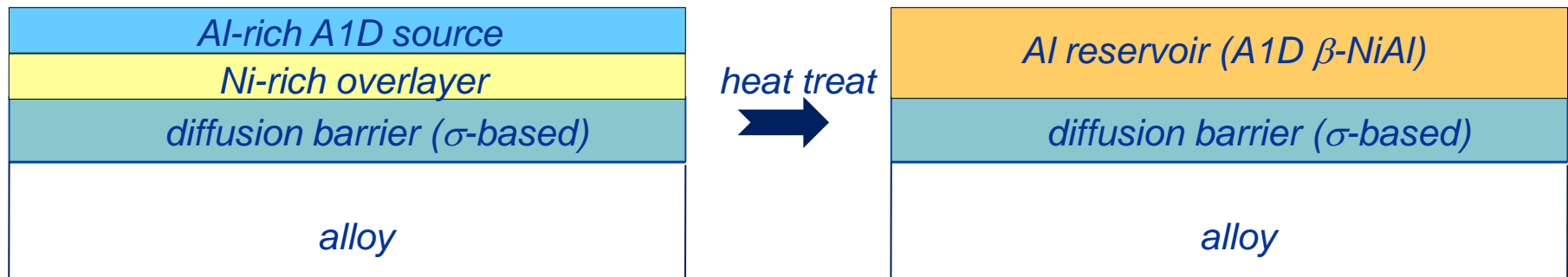

Diffusion Barrier Coatings with A1D

– NETL-CFI-UPitt-Ames –

– A1D Specifications for DBC Integration –

Test Campaign No.1 PWA 1484/Gen-1 DBC/A1D

- Received PWA 1484 with Ni-electroplated layer over Gen-1 DBC (T.Nariata courtesy B.Gleeson)
- 20 cycles of 1100°C thermal cycling led to significant degradation of the coated surfaces

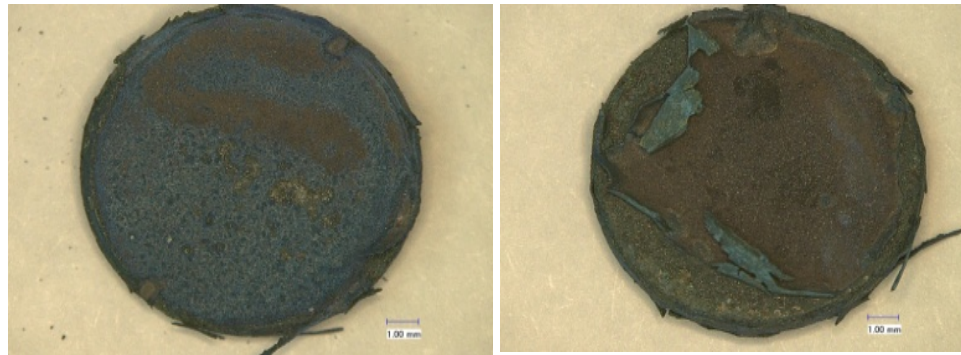
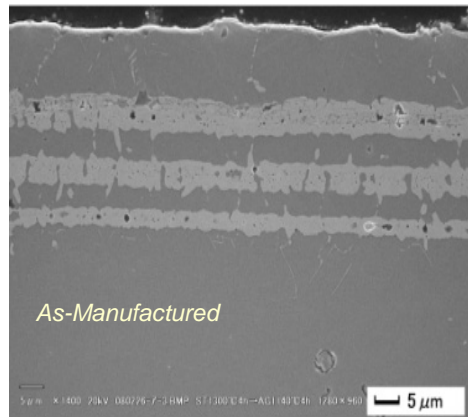

Coupons and micrograph courtesy of Brian Gleeson

Diffusion Barrier Coatings with A1D

– NETL-CFI-UPitt-Ames –

– A1D Specifications for DBC Integration –

Test Campaign No.2 René N5/Gen-1 DBC

- Received René N5/T.Narita's Gen1-DBC/~5 μ m electroplated-Ni layer
- CFI used standard grit blast on electroplated-Ni layer for surface preparation prior to A1D application
- Characterization intended to address:
 - Thickness of the remaining electroplated-Ni layer that was deposited on the DBC layer
 - Interaction of the A1D with the electroplated-Ni
 - Composition, microstructure, diffusion bond coat thickness

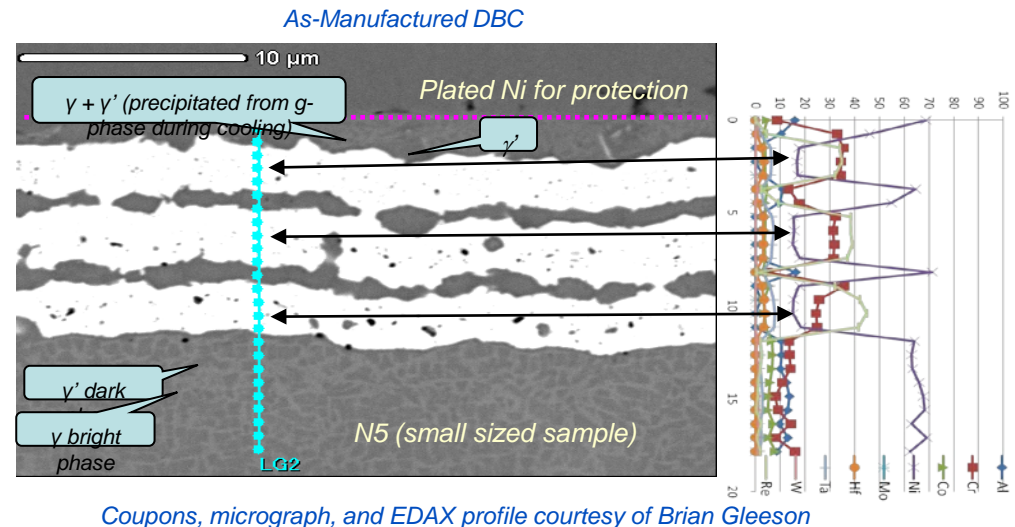

Diffusion Barrier Coatings with A1D

– NETL-CFI-UPitt-Ames –

– A1D Specifications for DBC Integration –

Test Campaign No.2

As-Manufactured René N5/ Gen-1 DBC/A1D

- Surface preparation
 - Minimal fracture of DBC surface with 40 psi, 100 grit alumina
- Diffusion of A1D into & through the DBC into the René N5 substrate resulted
- Re-rich precipitates were visible on the top of the coating, but no continuous DBC layer formed

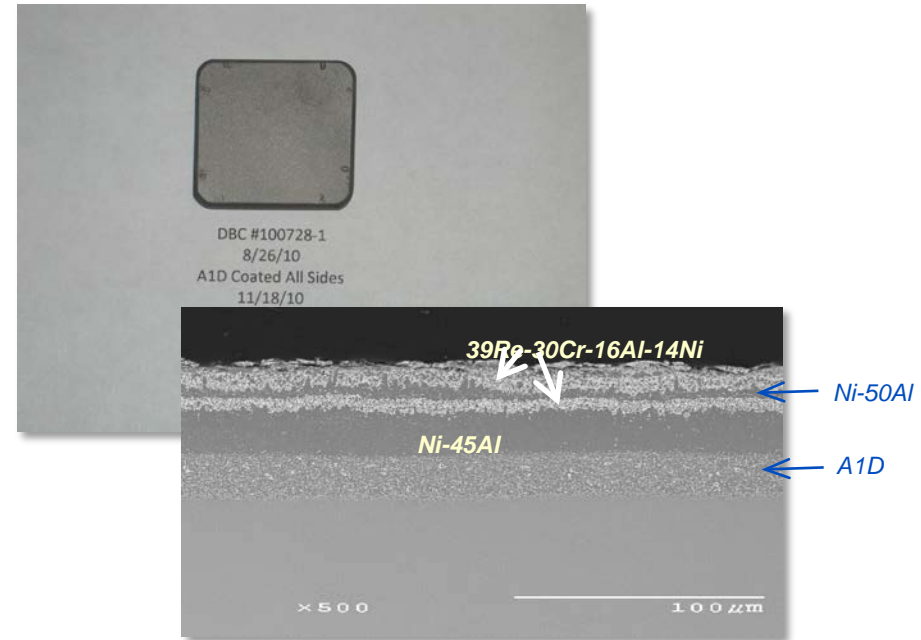

Diffusion Barrier Coatings

Test Campaign No.3

As-Manufactured Haynes 214/Gen-2 DBC

- DBC powder development at Ames Lab via high energy mechanical milling (Zoz mill)
- σ -DBC's were deposited by Caterpillar Inc's Technical Center via HVOF
 - Thick coating: 50Re-24Cr-26Ni (at%)
 - Thin coating: 72Re-14Cr-11Ni (at%)
- Al reservoir was a Praxair Ni-343 overlay (67Ni-22Cr-10Al-1Y (wt%)) deposited by HVOF

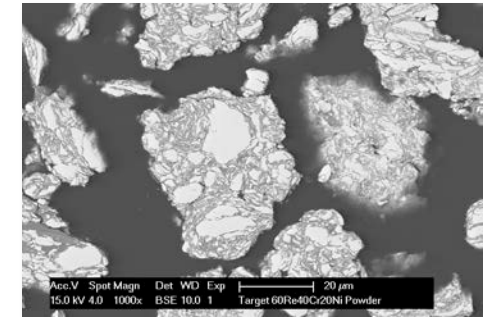
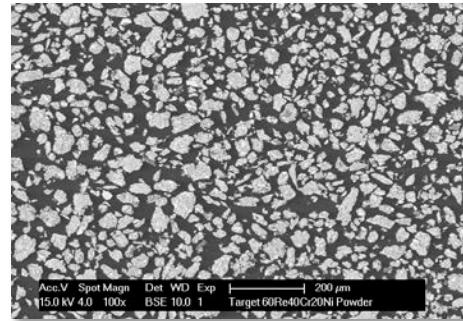

40Re-40Cr-20Ni (at. %) mixture mechanically milled at the Ames Laboratory using a Zoz Mill

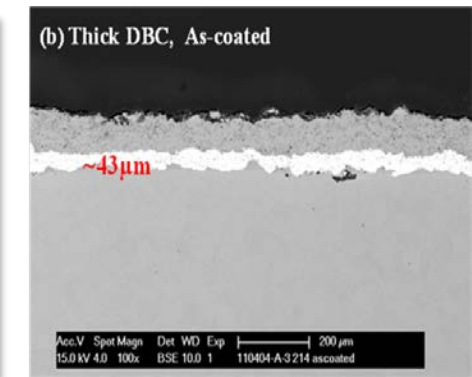
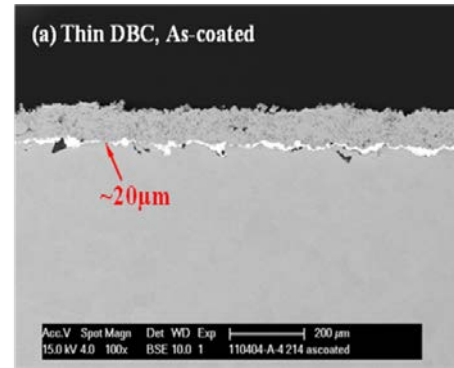

Representative cross-sectional micrographs of the as-manufactured (a) thin and (b) thick DBC systems

Diffusion Barrier Coatings

Test Campaign No.3

As-Manufactured Haynes 214/Gen-2 DBC

- *Bench-scale furnace testing at 1100°C — Thick Coating:*
 - *Little change in Re content after 100 hrs*
 - *Small amount of Cr-enrichment at NiCrAlY/DBC interface*
- *Bench-scale furnace testing at 1200°C — Thick Coating:*
 - *Re diffused from the DBC to the NiCrAlY coating, and Al from the coating to the DBC*
 - *Measurable change in the DBC composition with increasing exposure time, as well as temperature*
 - *Accelerated testing at higher temperatures cautioned*

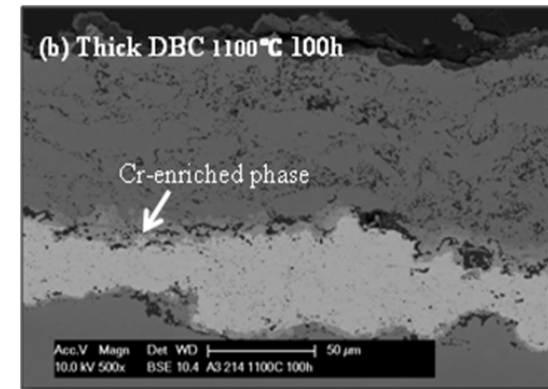
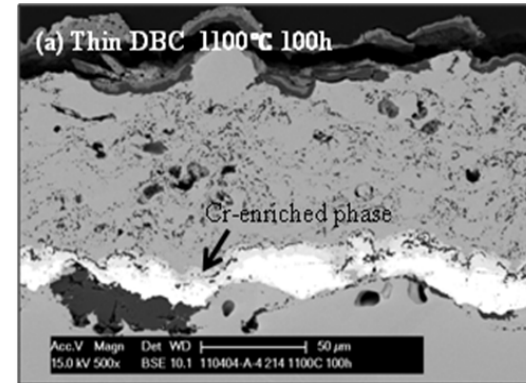

Cross-sectional micrographs of the (a) thin and (b) thick DBC systems after 100 hrs exposure at 1100°C (~2010°F)

Diffusion Barrier Coatings

Test Campaign No.3

As-Manufactured Haynes 214/Gen-2 DBC/A1D

- *Application of A1D onto thick DBC*
- *A1D diffusion bond coat was seen to be retained along the exterior surface of the DBC-coated Haynes 214 coupon*
- *Formation of a 50 μm external Ni_3Al layer*
- *Outward diffusion of DBC*
- *Inward diffusion of DBC*
- *Interface processing needs to be addressed*

- *Materials were not available for thermal cyclic testing*

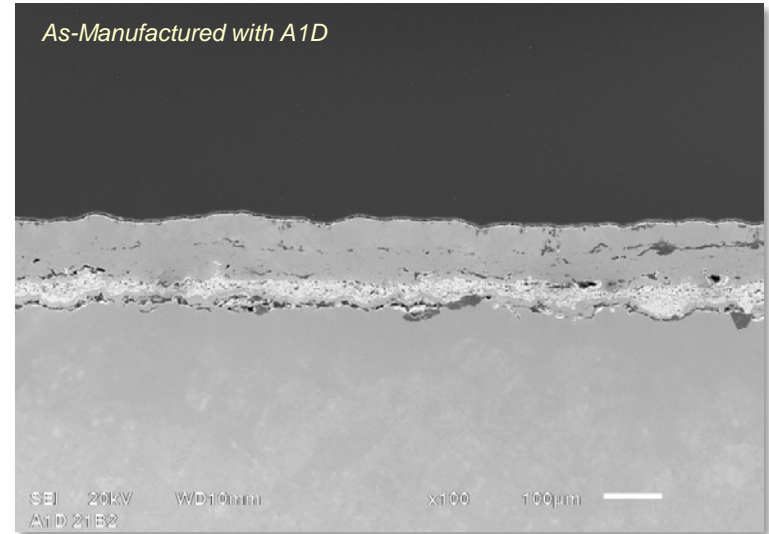

Diffusion Barrier Coatings

Test Campaign No.4

Haynes 230/Thermal spray ReNiCr (DBC)/Thermal spray Sulzer Metco 450 Ni5Al / A1D

- A1D retained along external DBC surface
 - Slurry formed Ni_3Al (22.6 at% Al) rather than NiAl as it diffused on Ni5Al
- Interconnected porosity remaining in the Ni5Al layer after diffusion (between arrows on lower left) micrograph, allowed severe internal oxidation at 1100°C
 - Interface processing issues to be resolved
- Coating partially detached from substrate after 129 cycles at 1100°C in static air
- Grain boundary oxidation of Haynes 230 (DBC interface) at 1100°C
 - Selection of substrate materials & Accelerated testing at higher temperatures cautioned

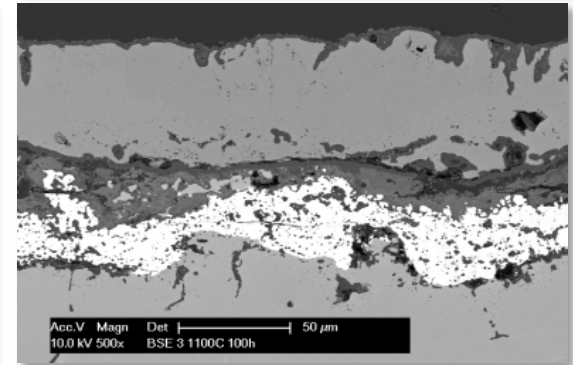
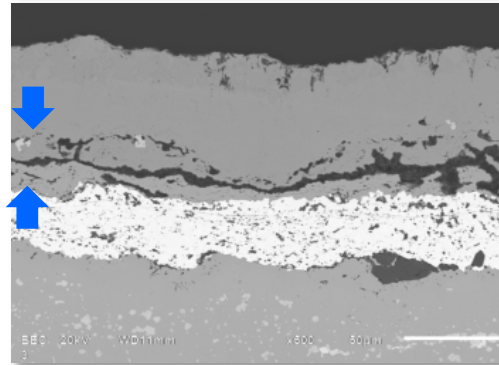
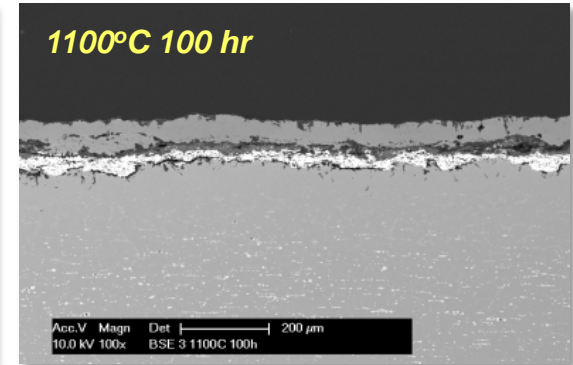
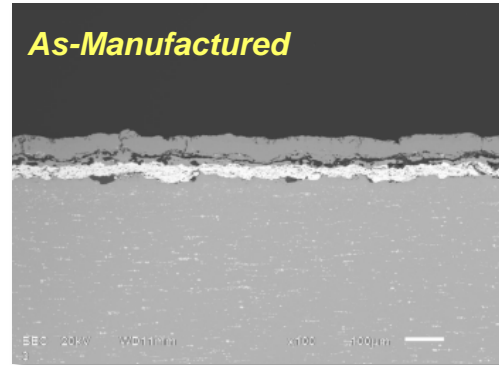

High Temperature Thermal Flux Testing

– Westinghouse Plasma Corporation & NASA GRC –



WPC High Temperature Thermal Flux Testing

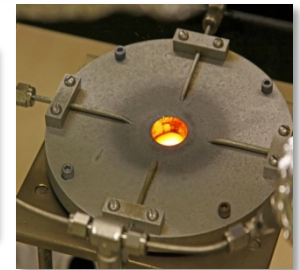
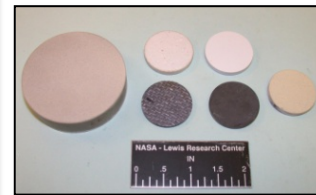
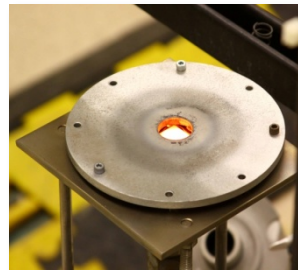
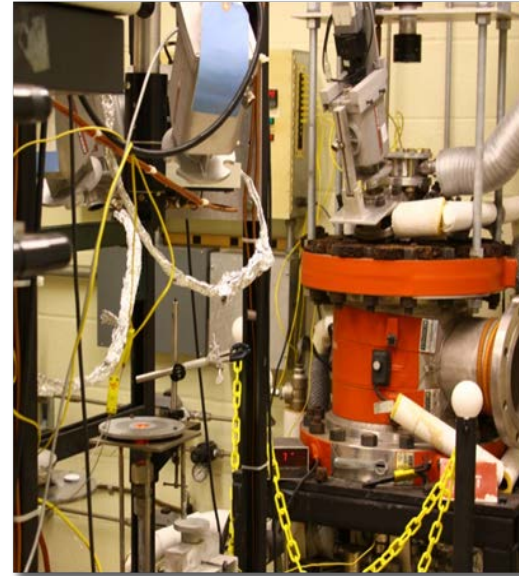

NASA GRC High Temperature Thermal Flux Testing

Composite Coating Architecture (APS)

– Thermal Cycling/Thermal Gradient –

Test No.	Substrate & Coating Composition	Steam	Temperature, °C				Visual Inspection
			Back Coupon Surface	Bond Coat Surface or Interface	YSZ Surface	Overlayer Surface	
1-4	René N5/LPPS MCrAlY/ Howmet APS YSZ/ APS ZrO ₂ -2.8wt%Y ₂ O ₃ - 3.3wt%Gd ₂ O ₃ -3.6wt%Yb ₂ O ₃	—	1000	1115	—	1482	Intact after 50 Cycles ^(a)
1-3	René N5/A1D/ Howmet APS YSZ/ APS ZrO ₂ -2.8wt%Y ₂ O ₃ - 3.3wt%Gd ₂ O ₃ -3.6wt%Yb ₂ O ₃	—	1018	1120	—	1482	Intact after 50 Cycles ^(b)
1-5	René N5/A1D/ Howmet APS YSZ/ APS ZrO ₂ -2.8wt%Y ₂ O ₃ - 3.3wt%Gd ₂ O ₃ -3.6wt%Yb ₂ O ₃	√	1050	1135	—	1482	Failed after 49 Cycles ^(c)

- (a) The estimated initial coating thermal conductivity was ~ 0.94 W/m-K; Thermal conductivity increased to ~1.14 W/m-K after the 10 cycle test; Thermal conductivity reduction in the further cycles test (reduced to ~1.10 W/m-K at ~28-29 cycles)
- (b) The estimated initial thermal conductivity of the coating was ~ 0.97 W/m-K; Thermal conductivity increased to ~1.13 W/m-K after the first cycle, reaching a maximum ~1.15 W/m-K in the first 5 thermal cycles; Increase possibly due to sintering and /or porosity reduction within the top coat layers; Very slight conductivity reduction resulted during further thermal cyclic testing (1.12 W/m-K after 50 hrs of testing); Reduction possibly due to defect formation (i.e., gaps; microcracks) within the topcoat or along TGO interface
- (c) The estimated initial coating thermal conductivity was ~ 0.99 W/m-K; Thermal conductivity increased to ~1.21 W/m-K after the first cycle test; Thermal conductivity reduction occurred during continued cyclic testing (reduced to ~0.7 W/m-K at ~38-39 cycles) due to partial coating delamination (average measured T_{surface} 1520-1550°C, T_{interface} up to ~975°C and T_{metal back} ~871°C); The coating had half spallation at 49th cycle; Remaining coating visually appeared to be intact

Composite Coating Architecture (APS)

Test No. 1-4: René N5/LPPS NiCoCrAlY/APS YSZ/ZrO312, Air, 50 hrs Thermal Cycling

- The coating visually appeared to be intact after testing
- Very minor edge buckling/spalling occurred

Microstructural Characterization

- Little evidence of TBC coating failure
- Although features of aluminum depletion in the bond coat were evident, a continuous alumina surface scale is maintained (~5-10 μm)
- Degradation within the NiCoCrAlY coating
 - Numerous large internal oxide formations
- No indication of cracking or delamination of the porous bilayer ceramic coating
- Some flaking of the porous plasma sprayed ceramic surface

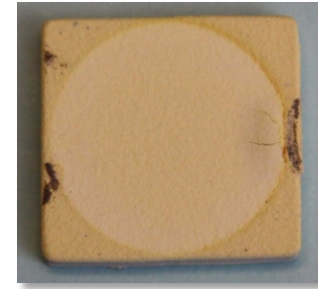

T1-4: Coupon tested in air at
~1482°C (2700°F), 50, 1 hr
cycles

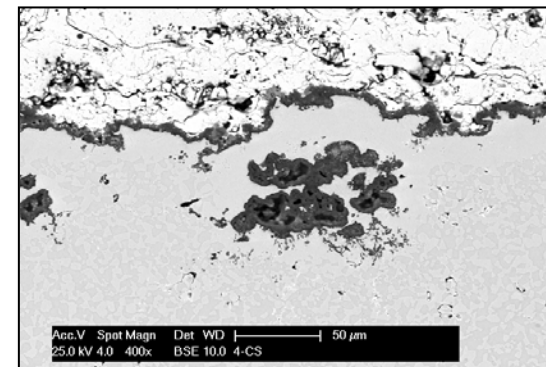
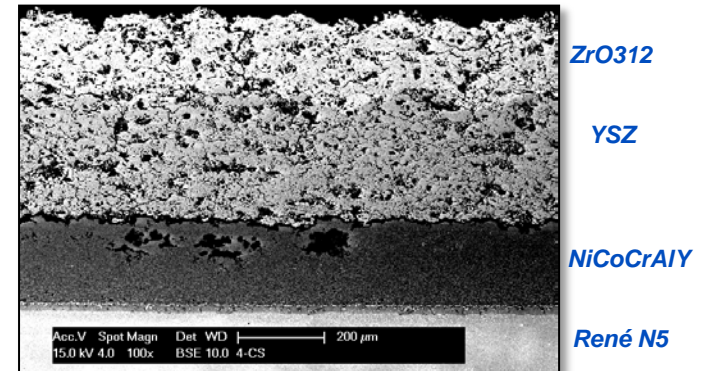

Composite Coating Architecture (APS)

Test No. 1-3: René N5/A1D/APS YSZ/ZrO312, Air, 50 hrs Thermal Cycling

- The coating visually appeared to be intact at test termination

Microstructural Characterization

- Little evidence of TBC coating failure
- Although features of aluminum depletion in the bond coat were evident, a continuous alumina surface ($\sim < 5 \mu\text{m}$) scale is maintained
- Absence of internal oxidation within the A1D diffusion bond coat
- A1D surface planarity retained
- No SRZ formation
- No indication of cracking or delamination of the porous bilayer ceramic coating
- Some flaking of the external ceramic surface

Comparison of A1D & NiCoCrAlY 1100°C Laser Flux Tests:

- NiCoCrAlY has more extensive internal oxidation than A1D
- A1D is likely to endure more thermal cycling prior to failure than NiCoCrAlY

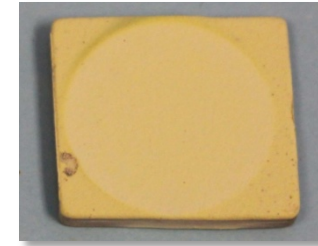

T1-3: Coupon tested in air at $\sim 1482^\circ\text{C}$ (2700°F), 50, 1 hr cycles

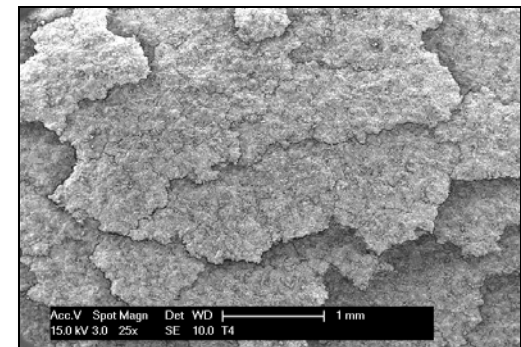
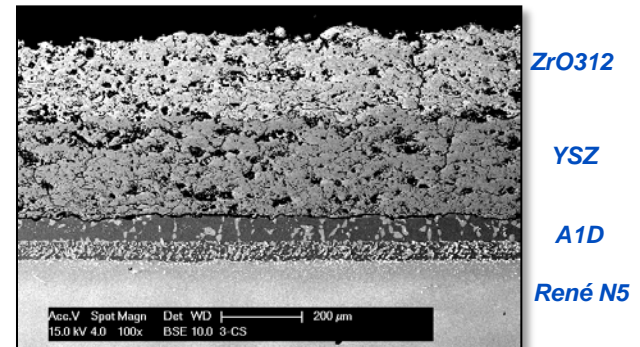

Composite Coating Architecture (APS)

Test No. 1-5: René N5/A1D/APS YSZ/ZrO312/Steam, 50 hrs Thermal Cycling

- The coating had half spallation at 49th cycle; Remaining coating visually appeared to be intact
- T_{surface} 1520-1550°C

Microstructural Characterization

- Delamination occurred in the TBC layer adjacent to the YSZ-bond coat interface
 - YSZ remained attached to the bond coat surface
 - Crack formations were evident in the ZrO312 layer
 - Absence of crack formations within the A1D bond coat
 - ~3-7 μm alumina formation on A1D
 - Planarity of A1D surface retained
 - No SRZ formation
- Prior art suggests ceramic coating delamination is the result of thermal mismatch between the bond coat and TBC layer
 - If this were the sole source for failure, failure should have occurred in Test 1-3 and Test 1-4 (air)
 - Prior art also suggests that water vapor increases the rate of alumina growth at HT
 - As internal stress in TBC increases as alumina growth increases, failure is likely
 - Note: No apparent significant increase in measured alumina thickness (~<5 μm to ~5 μm)
 - Issues raised: Coating application – A1D/YSZ interface surface roughness; Surface over-temperature exposure; Fixturing (clamping) of coated coupon in steam rig; Uniformity of laser intensity; Steam port injection location relative to delamination; Edge effect failure



T1-5: Coupon tested in water vapor at ~1482°C (2700°F), 49, 1 hr cycles

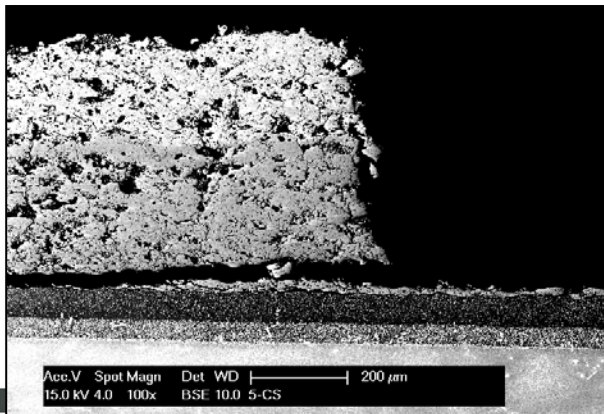

Composite Coating Architecture (EBPVD)

– Thermal Cycling/Thermal Gradient –

Test No.	Substrate & Coating Composition	Steam	Temperature, °C				Visual Inspection
			Back Coupon Surface	Bond Coat Surface or Interface	YSZ Surface	Overlayer Surface	
2-4	René N5/A1D/ P&W EB-PVD YSZ	√	975-1000	1100-1140	1300	–	Spalled after 20 Cycles ^(a)
2-5	René N5/A1D/ P&W EB-PVD YSZ/ EB-PVD ZrO ₂ -2.8wt%Y ₂ O ₃ - 3.3wt%Gd ₂ O ₃ -3.6wt%Yb ₂ O ₃	√	900	1120	–	1450-1460	Intact after 50 Cycles ^(b)
2-3	René N5/A1D/ P&W EB-PVD YSZ/ EB-PVD HfO ₂ -14mol%Y ₂ O ₃ - 3mol% Gd ₂ O ₃ -3mol%Yb ₂ O ₃	√	990	1120	–	1500-1520	Spalled after 50 Cycles ^(c)

- (a) Surface temperature increased (maximum surface temperature ~1400°C) at the 20th cycle due to a reduced steam flow; Interface maximum temperature ~1180°C for two cycles, and coating had local spallation, then quickly resulting in larger area buckling; The test terminated with the spalled thermal barrier coating.
- (b) Thermal conductivity initially increased due to sintering and later decreased due to possible minor coating delamination; Further cycling showed relatively stable or very minor reductions in thermal conductivity values.
- (c) Surface temperature increased (surface temperature over 1575°C) at the 6th - 13th cycle due to a sudden reduced steam flow; Interface maximum temperature around 1150°C for eight cycles, no visual coating damage with the over temperature cycles; Further cycling showing slightly conductivity reduction indicating some interface damage

Composite Coating Architecture (EBPVD)

Test No. 2-4: René N5/A1D/P&W EB-PVD YSZ

Spalled Area

- Evidence of extensive cracking in the YSZ
- Exposed surface contains alumina, nickel, chromium, as well as adherent remnants of YSZ
- $T_{interface} \sim 1180^{\circ}\text{C}$ (2 cycles)

Non-Spalled Area

- Segmented structure of EB-PVD TBC
- Areas with partial detachment of the TBC from the bond coat; Areas where TBC remains attached
- Failure of the TBC involved fracture of the TGO and subsequent detachment of the TBC
- Loss of aluminum from the A1D bond coat caused the formation of γ' along the metal-oxide interface, along the grain boundaries, and within the coating grains

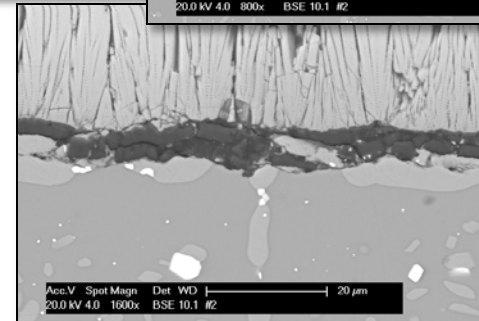
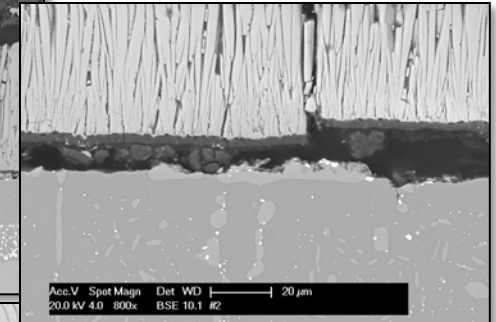
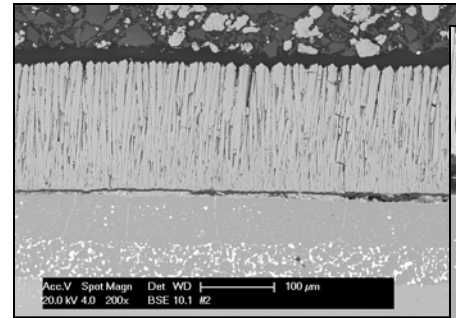
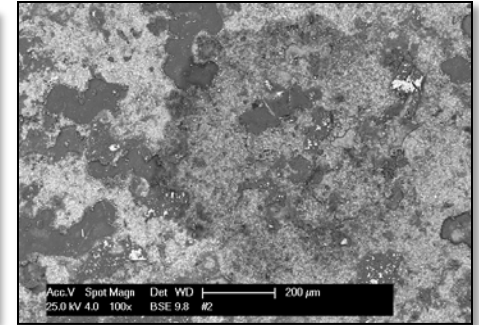
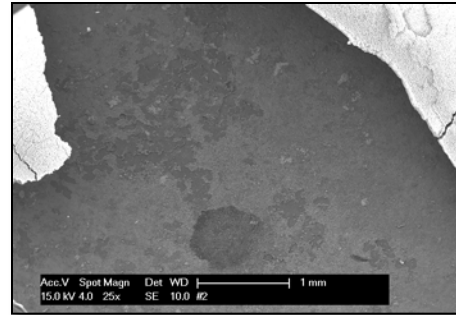

T2-4 Coupon tested in water vapor at
~1300°C, 20, 1 hr cycles

Composite Coating Architecture (EBPVD)

Test No. 2-5: René N5/A1D/P&W EB-PVD 7YSZ/EB-PVD ZrO_2 -2mol% Y_2O_3 -1mol% Gd_2O_3 -1mol% Yb_2O_3

Surface

- Irregular surface with extensive cracking
- Surface roughness may be related to columnar EBPVD structure

Cross-Sectional Analysis

- Bond coat is silicon modified aluminide
- ~23 μm alumina TGO formation
 - If >10 μm , then TGO is prone to cracking
- Zirconia appears to be dense adjacent to the TGO, while the remainder to the EBPVD is columnar
- Large cracks between the bond coat and TGO layer
 - ~10 cycles, thermal conductivity decreased due to minor cracking/coating delamination
- Aluminum depletion in the bond coat led to Ni_3Al (γ) at coating surface
- Coating degradation related to growth stress and thermal stress in the TGO layer vs degradation of the bond coat

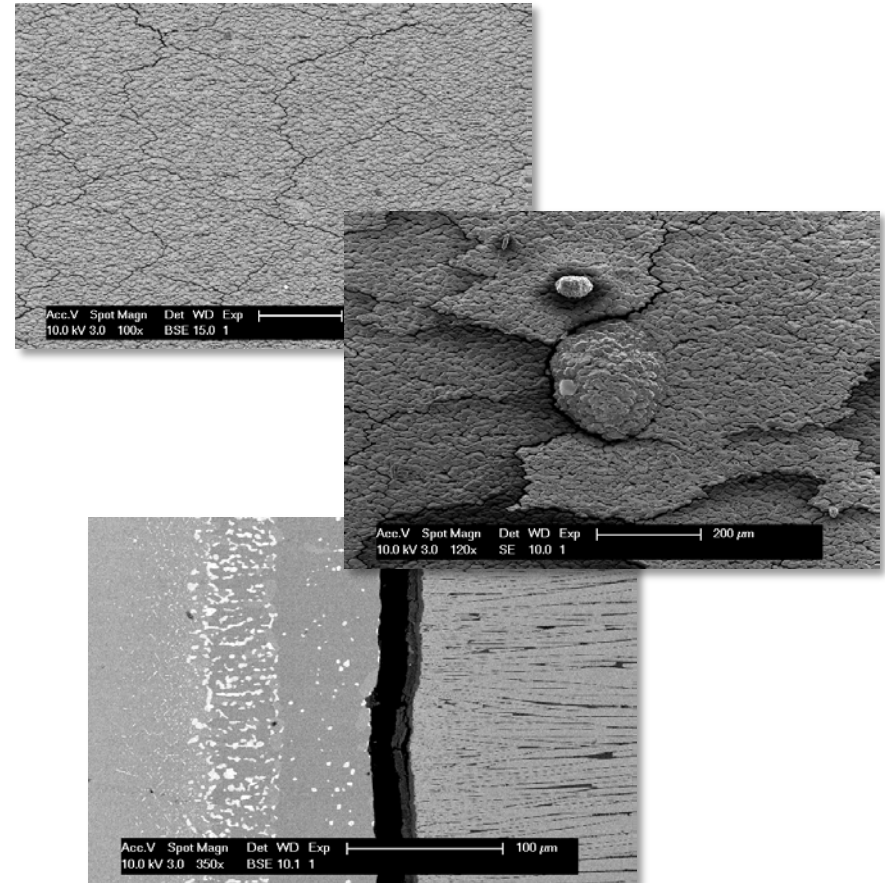

T2-5 Coupon tested in water vapor at ~1450°C, 50, 1 hr cycles

Composite Coating Architecture (EBPVD)

Test No. 2-3: René N5/A1D/P&W EB-PVD YSZ/HfO₂-14mol%Y₂O₃-3mol%Gd₂O₃-3mol%Yb₂O₃

Spalled Area

- Extensive cracking of the ceramic layer
- Spallation at the center of the heated area
- Residual ceramic is adherent to the TGO which contains both alumina and zirconia, or solely alumina
- Testing interval when $T_{\text{surface}} > 1575^{\circ}\text{C}$ with $T_{\text{interface}} \sim 1150^{\circ}\text{C}$

Non-Spalled Area

- Segmented structure of the EBPVD TBC
- Large crack formations with removal of the TBC
- Bi-layer TBC architecture
 - Complex ceramic on top surface of YSZ
- Little evidence of a continuous alumina layer on the A1D bond coat
 - Oxide between the stabilized zirconia and the diffusion aluminate appears to be a mixture of alumina and stabilized zirconia grains
- TGO appears to be extensively fractured
 - TBC failure may have been caused by growth and coalescence of the TGO crack formations

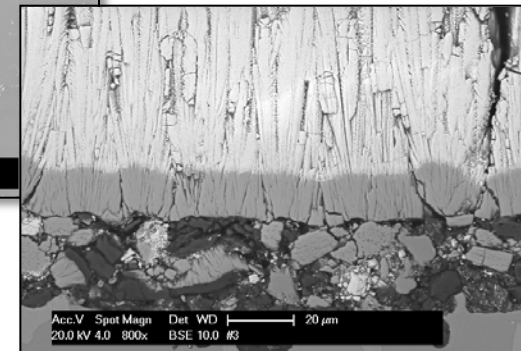
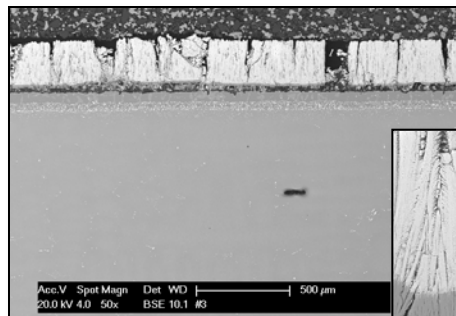
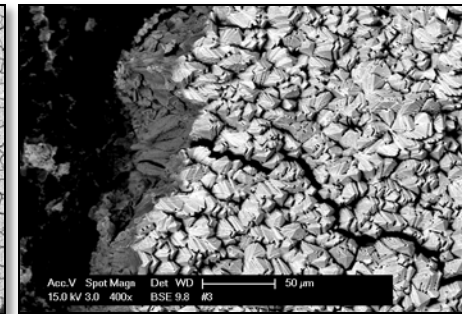
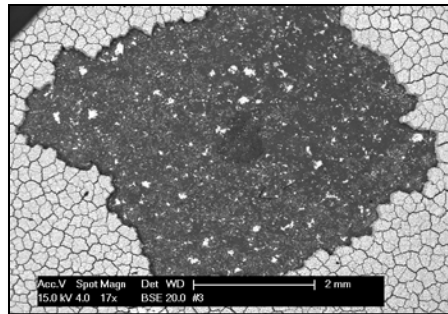

T2-3 Coupon tested in water vapor at
~1500-1520°C, 50, 1 hr cycles

NETL-RUA Turbine Thermal Management Project

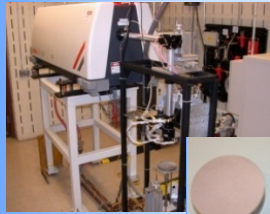

NASA GRC High Temperature Thermal Flux Testing

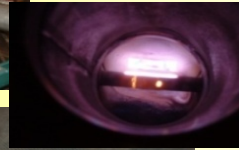

Westinghouse Plasma Corp High Temperature Thermal Flux Testing

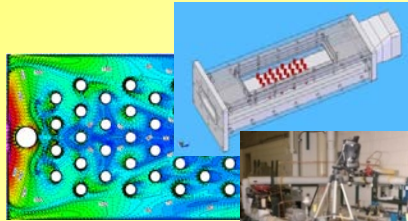

Heat Transfer Test Facility at Pitt



VT's Cascade, Low Speed Wind Tunnel, and Tripod Hole Configurations

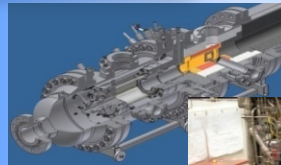

NETL's High Temperature, Pressurized Aerothermal Test Facility

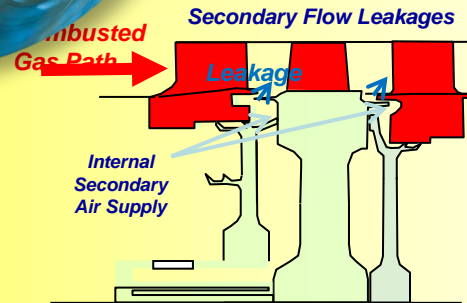

Zero Leakage Secondary Air System at PSU

NETL-RUA Turbine Thermal Management Project – Airfoil Internal Cooling –

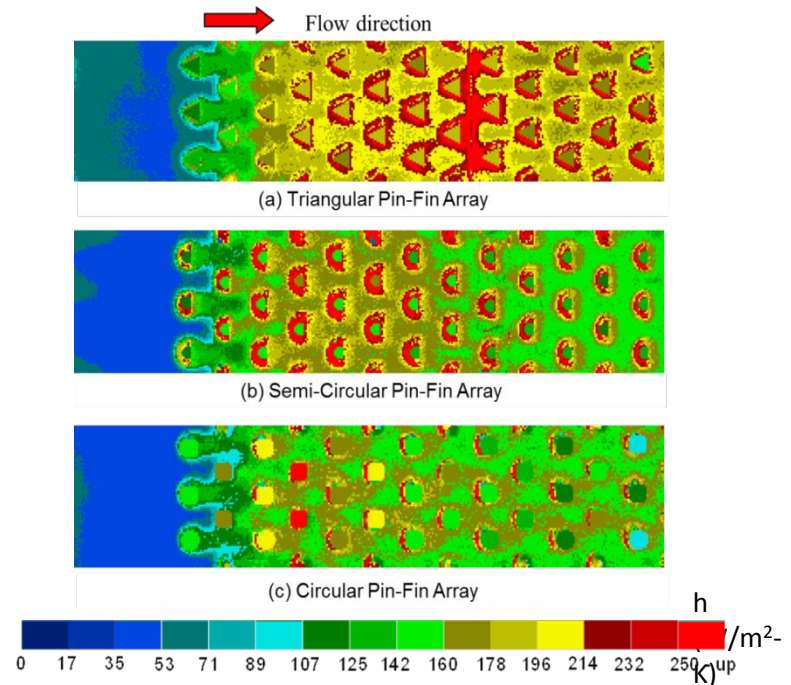
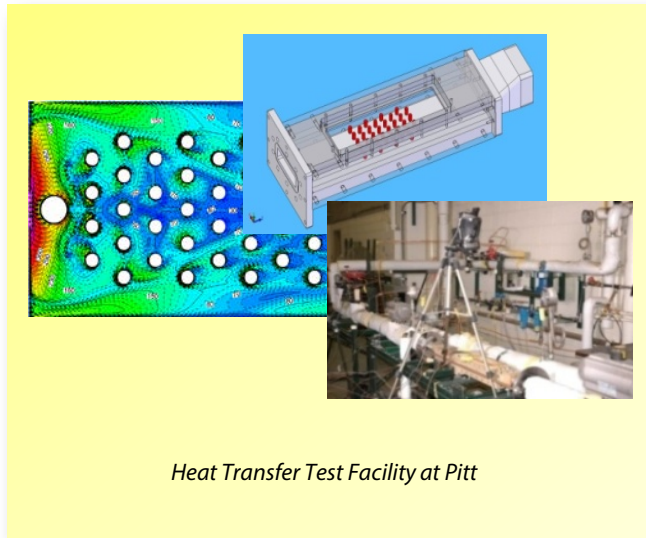

- Develop cooling technologies that are capable of yielding a heat transfer enhancement factor nearly 5 times the smooth channel baseline and which are reasonably manufacturable
- Develop core competency, design and proof-of-concept testing of the NETL-RUA Near Surface Embedded Micro-Channel (NSEMC) Concept (Patent Application submitted, December, 2011)

- Triangular, semi-circular, and circular pin-fin arrays assessed as internal turbulators for enhanced internal turbine airfoil heat transfer enhancement
 - Triangular pin-fin array has higher heat transfer
 - Presence of sharp edges that generate additional wake, resulting in better flow mixing
- NSEMC models have been designed and constructed
 - Addressing hole diameter, location, surface turbulators
 - Initial design assessed in terms of manufacturability

NETL-RUA Turbine Thermal Management Project

– Airfoil Trailing Edge Cooling –

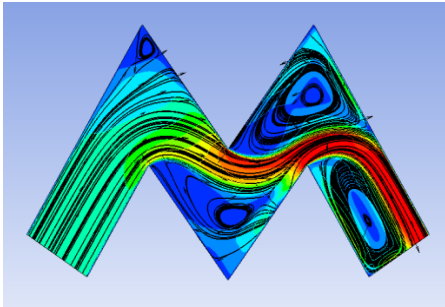

a) Zig-Zag Channel with 70° Turns

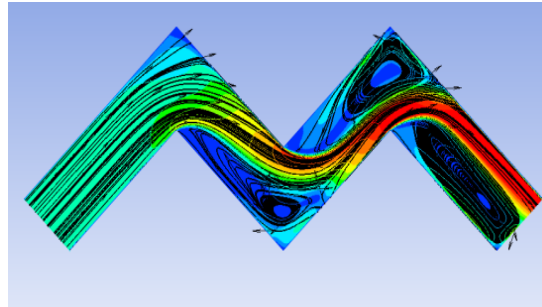

b) Zig-Zag Channel with 90° Turns

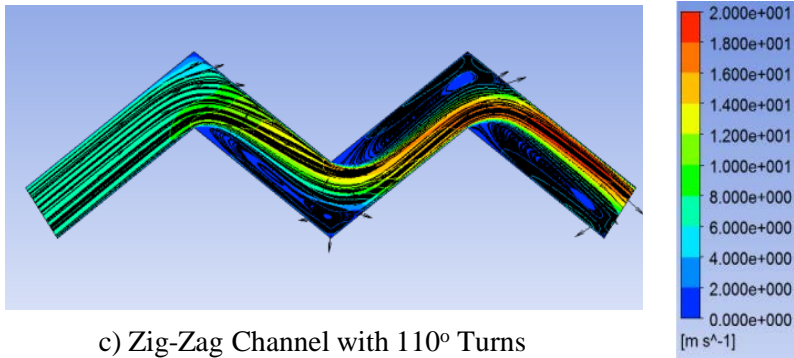

c) Zig-Zag Channel with 110° Turns

- ANSYS CFD modeling and experimental testing
- Designs consisting of 110° turning angle zig-zag passages numerically exhibited the highest heat transfer, h , in comparison to 70° and 90° turning angle zig-zag passages.
- The heat transfer performance in the zig-zag channel is enhanced after every turn within the flow domain due to turbulence and mixing
- Overall heat transfer enhancement in the zig-zag channel is enhanced by ~ 1.7 times in comparison to the fully developed smooth channel
- The pressure loss of the zig-zag channel seems to be insensitive to the $Re = 15,000-30,000$
- Rib-turbulators throughout the entire zig-zag channel, increase heat transfer enhancement by \sim two-fold in comparison to the smooth zig-zag channel
- Where all passages contain rib-turbulators, pressure loss is $\sim 30-90\%$ higher than that of the zig-zag smooth counterpart

NETL-RUA Turbine Thermal Management Project – Airfoil Film Cooling –

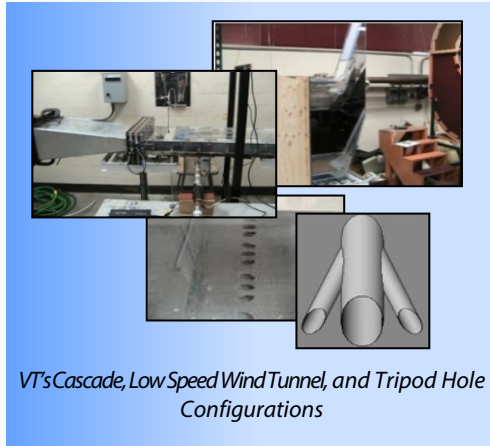

- Parameters explored included the spacing between hole groups and the divergence angle of the outside legs of the tripod design

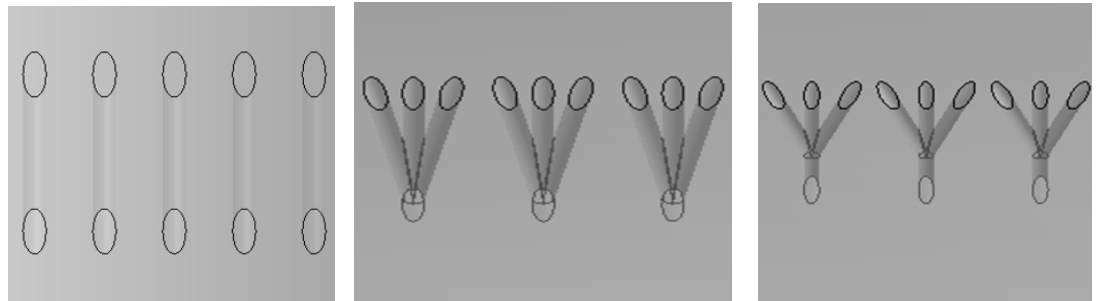

- Utilize the **tripod hole design** to demonstrate a **50% reduction in film cooling flow usage**

- Aerodynamic benefits:
 - The tripod holes showed minimal disruption to the downstream flow pattern at all blowing ratios, while the cylindrical and shaped holes disrupted the flow pattern, especially at high blowing ratios
 - With almost half the coolant mass flow, the tripod holes proved to have better cooling effectiveness as a result of better lateral diffusion in the near hole region
- Tripod hole manufacturability was assessed. No issues with construction identified.
- A thermo-mechanical stress analysis was conducted for the cylindrical and tripod hole designs. The magnitude of the stress was similar for both cases, indicating that thermal stresses will not be the limiting factor of the tripod design.

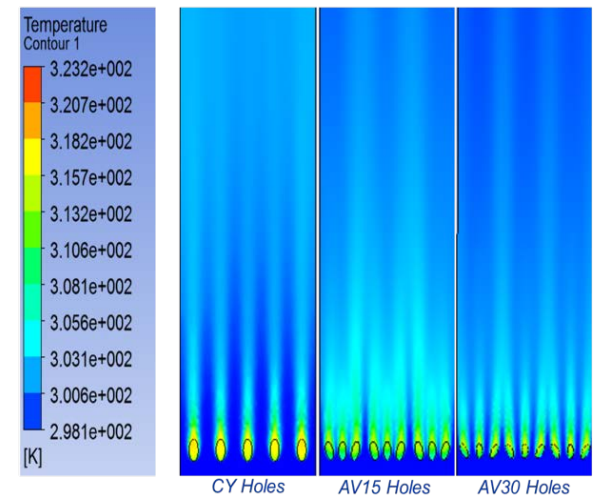

NETL-RUA Turbine Thermal Management Project

– High Temperature, Pressurized Testing –

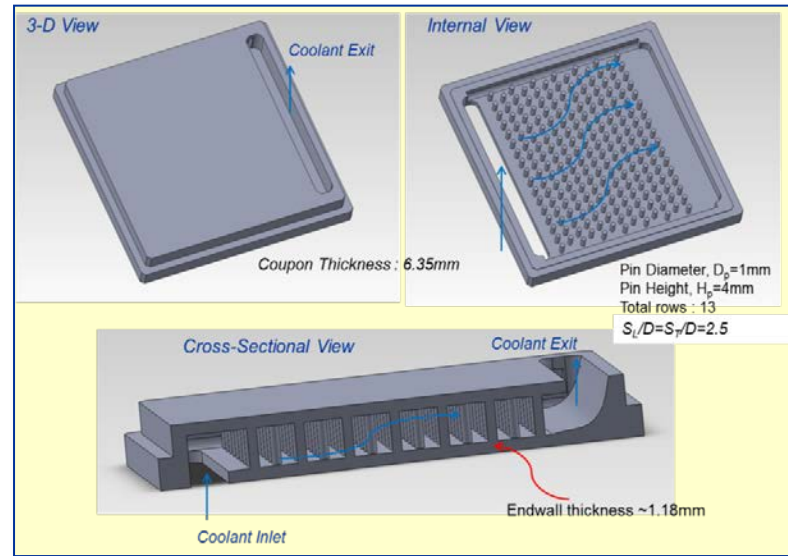
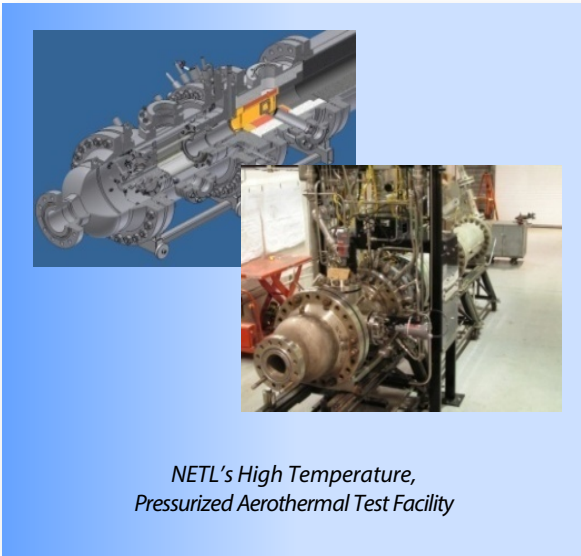

- FY12 – Validated surface temperature measurements with optical pyrometer and thermocouples
- Utilize **state-of-the-art manufacturing** technologies, construct “coupon-scale” integrated material/component systems, and demonstrate performance in NETL’s aerothermal test facility
- Initiate **advanced material system** (CMC & ODS) development/OEM interactions/testing. Support NETL-RUA patent application NSEMC

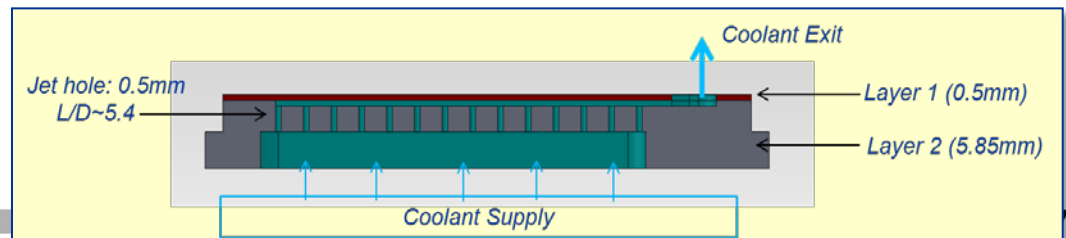
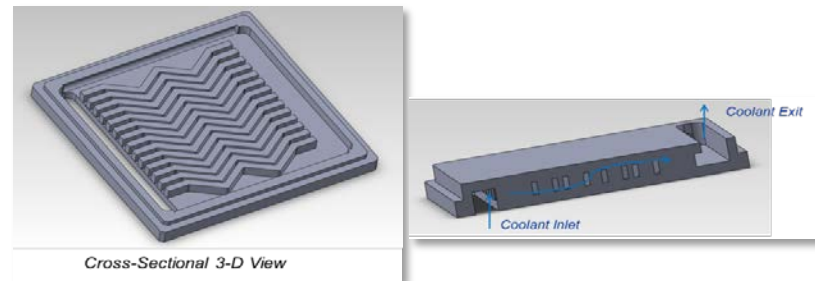

NETL-RUA Turbine Thermal Management Project – Secondary Flow Rotating Rig –

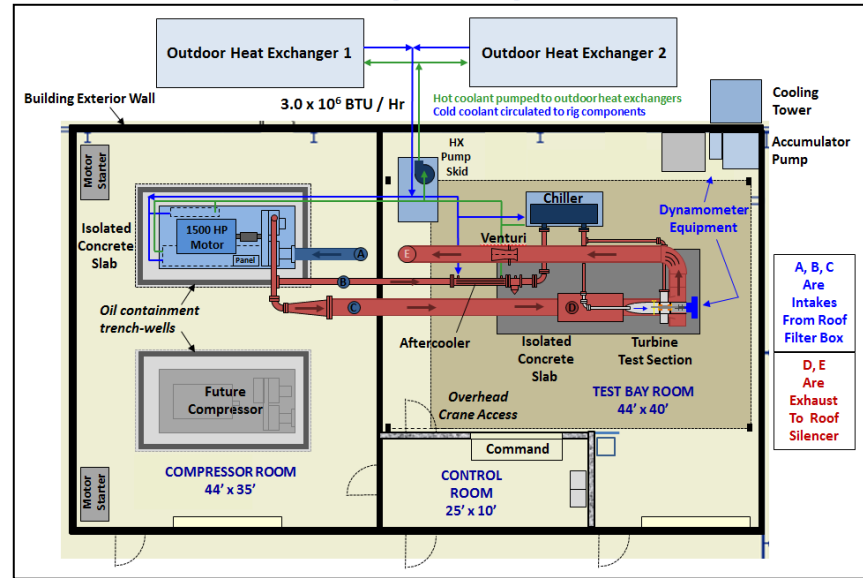
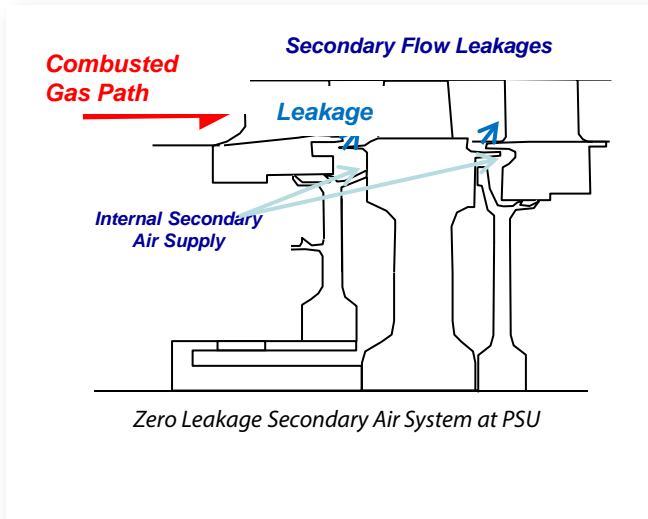

F.S.Elliott P700 1,500 Horsepower Centrifugal Compressor System

- Design/construct/operate an NETL-RUA world-class **rotating rig** for studying leakages, secondary flows and internal heat transfer in high speed rotating airfoils
- Demonstrate capabilities for reduction of secondary flow leakages in power generation turbines to reduce fuel burn (i.e., **3.34% leakage reduction = 1.95% fuel burn reduction**)
- 1.5 stage high pressure rotating turbine (vane/blade/vane) to study
 - The influence of leakage flows from the internal air system on turbine stage aerodynamics and heat transfer
 - The cooling flow performance within airfoils under rotation and with internal air system leakage
 - The impact of separately optimized designs (aero, rim cavity, durability) versus combined system optimized designs

Acknowledgments

We acknowledge Mr. Richard Dennis and Ms. Rin Burke at DOE NETL for their support

Collaborative efforts are being performed under the NETL-Regional University Alliance (RUA)

Contract DE-FE-0004000

Turbine Thermal Management Field Work Proposal Number 2012.03.02

This presentation was prepared as an account of work sponsored by an agency of the United States Government. Neither the United States Government nor any agency thereof, nor any of their employees, makes any warranty, express or implied, or assumes any legal liability or responsibility for the accuracy, completeness, or usefulness of any information, apparatus, product, or process disclosed, or represents that its use would not infringe privately owned rights. Reference herein to any specific commercial product, process, or service by trade name, trademark, manufacturer, or otherwise does not necessarily constitute or imply its endorsement, recommendation, or favoring by the United States Government or any agency thereof. The views and opinions of authors expressed herein do not necessarily state or reflect those of the United States Government or any agency thereof.